

WaterPex Single Layer Pe-Xb Piping

System Design and Application Classifications

Pipe Material	Applications	Service Temperatures	Maximum Working Pressure
PE-xb	Hot & cold water supply, under floor heating, radiator heating, etc.	-40°C - +90°C	16mm – PN16 20mm – PN12.5 25mm – PN12.5 32mm – PN12.5

SDR Values for WaterPex Pex-b Piping

SDR values are commonly referred to for single layer pex piping systems for water. The SDR values of WaterPex single layer Pex-b piping is shown in the following table.

DN Size	Maximum Outside Diameter (mm)	Minimum Wall Thickness (mm)	Wall Thickness Tolerance (mm)	SDR Value
16mm x 2.0	16.3	2.0	2.0 - 2.3	9
20mm x 2.0	20.3	1.9	2.0 - 2.3	11
25mm x 2.0	25.3	2.3	2.3 - 2.7	11
32mm x 2.0	32.3	2.9	2.9 x 3.3	11

WaterPex Single Layer Pe-Xb Piping System Design and Application Classifications



WaterPex Pex-b Piping is Suitable for Hot Water Systems

The Australian Standard AS3500.4-2015 clause 2.4.1(a)(i), requires that pipes up to DN100 shall have a maximum allowable operating pressure of at least 1.0 MPa at 60 deg C.

Rifeng DN20 piping has been independently tested by SKZ Germany for compliance to this requirement (Test Report no. 69287/05). The SKZ testing demonstrates that the Rifeng DN20 (SDR11) PN12.5 pipe can withstand working pressures well in excess of 1.0 MPa at 60 deg.C. **See Appendix 1** for detailed test reports and expert opinion.

WaterPex Piping System is Designed for a 50 year life span

WaterPex Pe-Xb product has been tested by SKZ Germany for the Determination of Long Term Hydrostatic Strength in compliance with ISO 9080:2003-10 and has been shown to have a predicted working life of greater than 50 years. The full SKZ report is provided in **Appendix 1**

Independent testing of WaterPex Products

Independent testing of WaterPex product has been conducted by ExcelPlas laboratories. The following properties were tested for compliance to Australian Standards requirements:

- > **Degree of Crosslinking**
- > **Thermal Stability**
- > **Dimensions**
- > **Out of Roundness**
- > **Surface Finish (Internal)**
- > **Tensile elongation**
- > **Resistance to Micro-cracking under 180 degree flex.**

Please see full reports in Appendix 2

Chlorination capacity and test results

The WaterPex piping system has been tested to material standards ASTM F876-2013 and NSF14 by NSF International to determine its' resistance to Chlorine. The product was found to have the highest level of Chlorine resistance.

The full NSF report is provided in Appendix 3

UV Rating

The WaterPex black coloured piping system has more than 2% carbon black and is UV rated. Other product colours (red, blue, green and lilac) do not contain carbon black and are not UV rated. Regardless of UV resistance, current regulations require all Pe-X systems to be protected from direct exposure to UV light. A UV rated conduit is provided for the WaterPex system.

WaterPex Single Layer Pe-Xb Piping

System Design and Application Classifications

Recommended Spacing of Brackets and Clips for WaterPex system

Piping for water supply	Max. Recommended spacing of Brackets and Clips (m)	
Size	Horizontal or grade pipes	Vertical pipes
16mm	0.60	1.20
20mm	0.70	1.40
25mm	0.75	1.50
32mm	0.85	1.70
40mm	0.90	1.80
50mm	1.05	2.10
63mm	1.10	2.20

Drawing on AS3500.5:2012 Table 2.14.4 for cold and heated water

Volume per metre of pipe

DN Size	ID	Radius (cm)	Radius (cm)	Height (cm)	PI	Volume (ml/metre)	Volume (litre/metre)
16mm x 2.0	12	6	0.6	100	3.14	113.1428571	0.113
20mm x 2.0	16	8	0.8	100	3.14	201.1428571	0.201
25mm x 2.0	20	10	1	100	3.14	314.28571473	0.314
32mm x 2.0	26	13	1.3	100	3.14	531.1428571	0.531

WaterPex Single Layer Pe-Xb Piping

Water Flow Rate

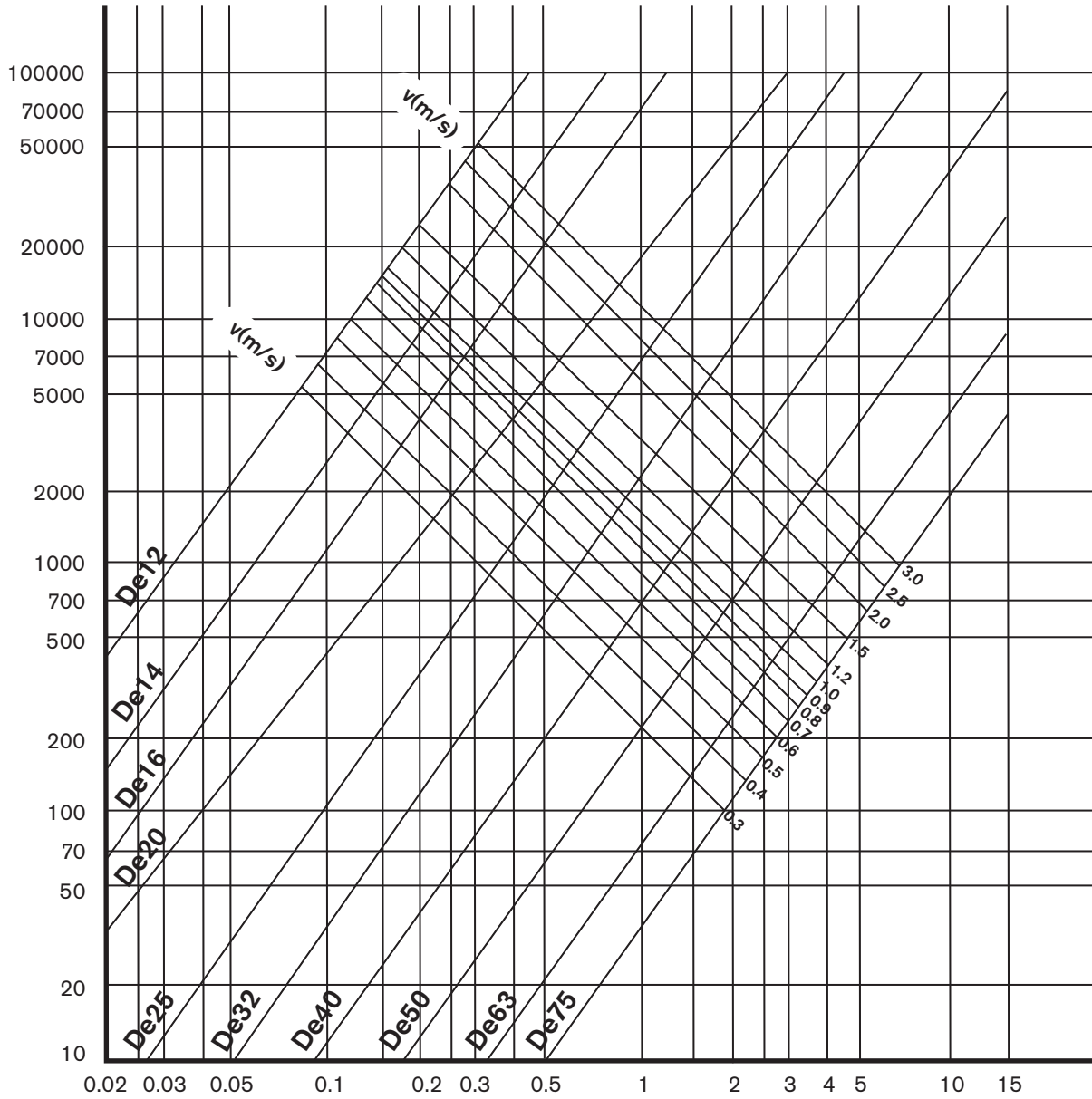

Flux L/s

Water temperature: 10°C Medium: water

Figure 1: pressure loss diagram of cold water pipe

WaterPex Single Layer Pe-Xb Piping

Water Flow Rate

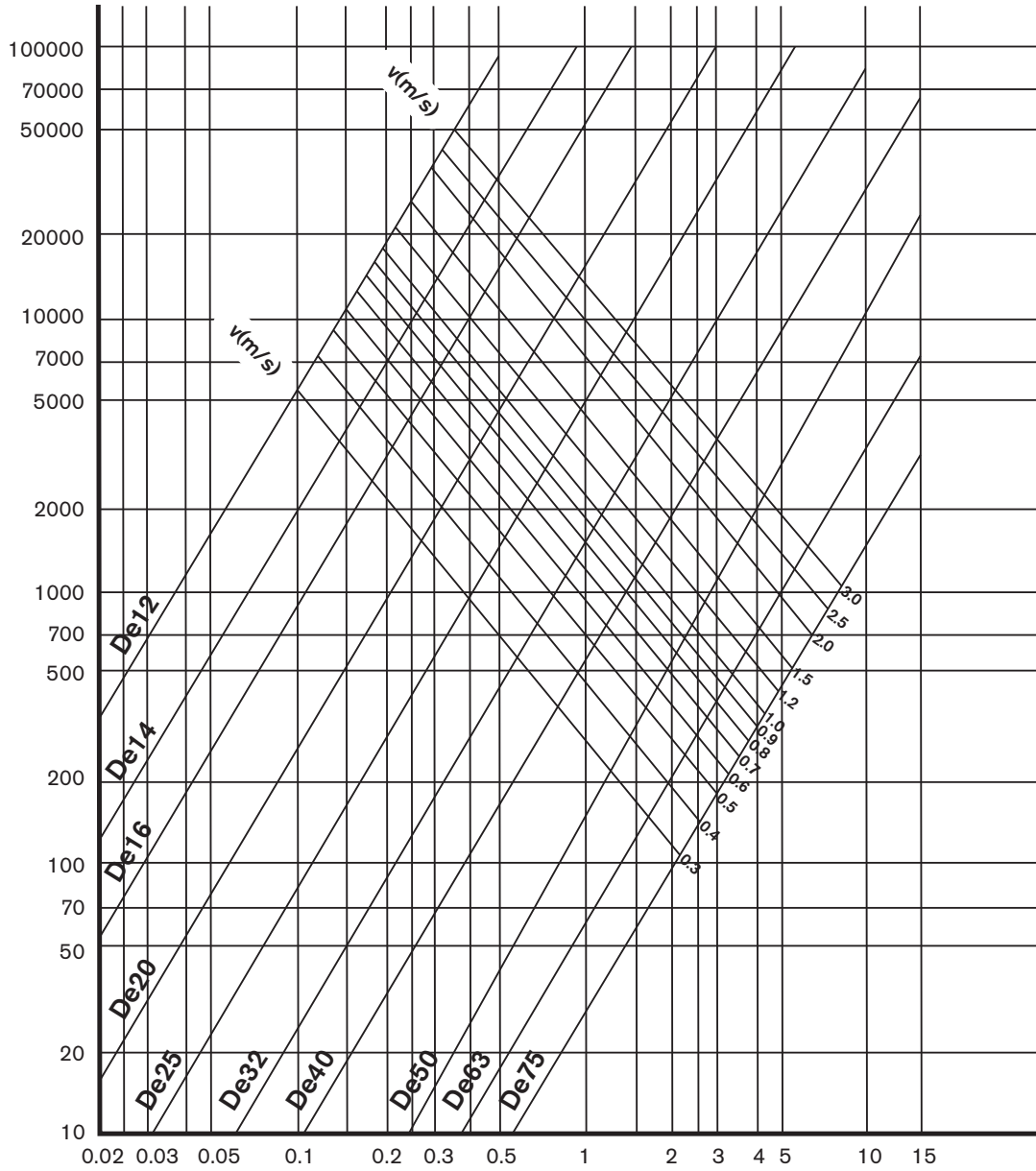

Flux L/s

Water temperature: 65°C Medium: water

Figure 1: pressure loss diagram of hot water pipe

WaterPex Single Layer Pe-Xb Piping

Water Flow Rate



Pressure loss diagram and tables for single layer Pex pipe

Each liquid loses energy when it flows through a pipe as a result of the force of friction of the liquid against the walls of the pipe. The diagram and tables show the pressure loss depending on the pipe diameter and the flow speed for a given volume flow.

The following tables represent the pipe pressure loss and the flow rate as a function the volume flow for water (10°C). The calculation of the pressure loss values in the tables are based upon the Bernoulli Equation.

OD x e	16 x 2		20 x 2 mm	
	Speed (m/s)	Pressure loss (hPa/m)	Speed (m/s)	Pressure loss (hPa/m)
0.01	0.09	0.26	0.05	0.08
0.02	0.18	0.52	0.11	0.18
0.03	0.27	1.36	0.16	0.26
0.04	0.35	2.14	0.21	0.61
0.05	.044	3.19	0.26	0.89
0.06	0.53	4.42	0.32	1.28
0.07	0.62	5.82	0.37	1.65
0.08	0.71	7.37	0.42	2.05
0.09	0.80	9.09	0.48	2.59
0.10	0.88	10.74	0.53	3.09
0.15	1.33	22.12	0.79	6.20
0.20	1.77	36.47	1.06	10.40
0.25	2.21	53.79	1.32	15.23
0.30	2.65	73.90	1.59	21.10
0.35	3.09	96.70	1.85	27.5
0.40	3.54	122.67	2.12	34.91
0.45	3.98	150.59	2.38	42.74
0.50	4.42	180.92	2.65	51.58
0.55	4.86	213.60	2.91	60.76
0.60	5.31	245.32	3.18	70.97
0.65	5.75	286.69	3.44	81.43
0.70	6.19	326.18	3.71	92.94
0.75	6.63	367.83	3.97	104.64
0.80	7.07	411.60	4.24	113.17
0.85			4.50	130.30
0.90			4.77	144.20
0.95			5.03	158.33
1.00			5.30	173.50

WaterPex Single Layer Pe-Xb Piping

Water Flow Rate

OD x e	16 x 2		20 x 2 mm	
	Volume flow Q (l/s)	Speed (m/s)	Pressure loss (hPa/m)	Speed (m/s)
0.10	0.32	0.97	0.19	0.28
0.20	0.64	3.25	0.38	0.94
0.30	0.95	6.48	0.57	1.91
0.40	1.27	10.77	0.75	3.09
0.50	1.59	15.96	0.94	4.58
0.60	1.91	22.00	1.13	6.33
0.70	2.23	28.85	1.32	8.30
0.80	2.55	36.49	1.51	10.51
0.90	2.86	44.60	1.70	12.93
1.00	3.18	53.69	1.88	15.42
1.10	3.50	63.50	2.07	18.25
1.20	3.82	74.01	2.26	21.28
1.30	4.14	85.20	2.45	24.51
1.40	4.46	97.05	2.64	27.93
1.50	4.77	109.17	2.83	31.54
1.60	5.09	122.30	3.01	35.14
1.70			3.20	39.11
1.80			3.39	42.26
1.90			3.58	47.59
2.00			3.77	52.10
2.10			3.96	56.78
2.20			4.14	61.38
2.30			4.33	66.39
2.40			4.52	71.57
2.50			4.71	76.92
2.60			4.90	82.43
2.70			5.09	88.10

Pressure loss table, single layer Pex pipe

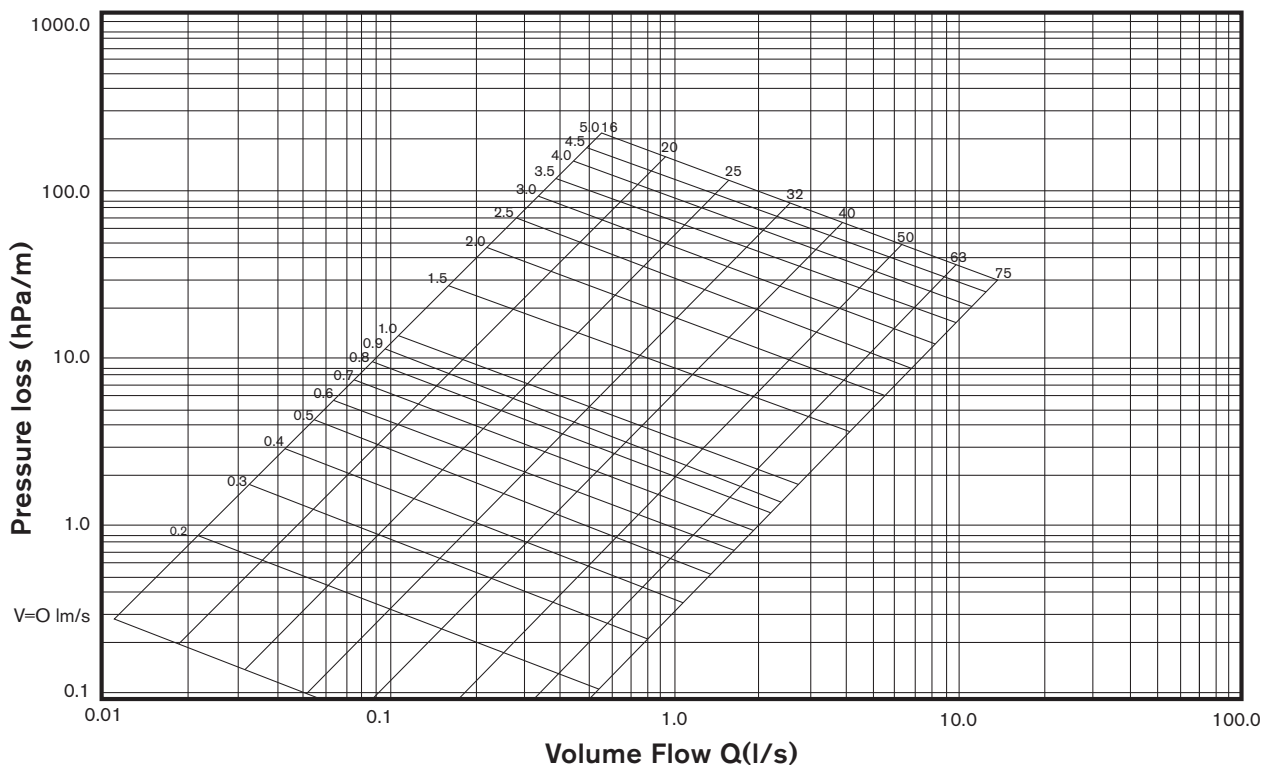





WaterPex Double Leak Detection Fittings

Technical Information

(1) Design, materials of construction and operating conditions

Application	Cold water, hot water
Working Temperature	-20°C ~ 95°C
Maximum working pressure	10 Bar
Application	Class 1,2/10Bar, Class 4,5/6Bar
Materials of Construction	Body - DZR brass Sleeve - SS304 Isolating Ring - Polyethylene Orings - HNBR

(2) Pressure loss

Inside Dimension (mm) Outside Dimension (mm)	1216		1620		2025	
	ξ	eL	ξ	eL	ξ	eL
Press Elbow 90 	1.2	1.44	1.01	1.52	1.01	1.81
Equal Straight Union 	0.81	0.97	0.62	0.94	0.62	1.11
Straight at flow speed 	0.86	1.03	0.67	1.00	0.66	1.19
Branch at flow speed 	1.77	2.12	1.58	2.37	1.57	2.83

3) The torque resistance of thread

Thread Size	1/2"	3/4"	1"	1 1/4"	1 1/2"	2"	2 1/2"
Torque / N-m	75	100	125	160	200	250	300

4) Fitting stress corrosion resistance

All fittings are tested according to ASTM B858 "Standard Test Method for Ammonia Vapour Test for Determining Susceptibility to Stress Corrosion Cracking in Copper Alloys"

It is required that there shall be no evidence of cracking when viewed with a microscope with a minimum magnification of 10X.

WaterPex Double Leak Detection Fittings

Design Features

Leak detection U-profile press fitting with double leakage indication



Leakage Indication 1
Haven't been pressed



Leakage Indication 2
After being pressed

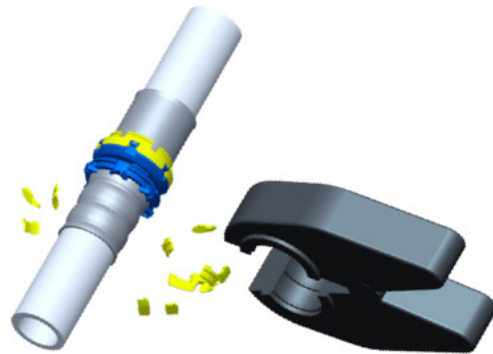

Technical Features:

Size: 16mm - 25mm
Temperature range: -40°C - 95°C
Pressure range: 0-10 Bar
Pressing profile: U

Design Criteria:

EN ISO21003, NK 18
DVGW W534, AS4176
AS537 .2



WaterPex F5 Fittings

Technical Information

(1) working media; working temperature/pressure

Application	Cold water, hot water, gas and compressed air
Working Temperature	-20°C ~ 95°C

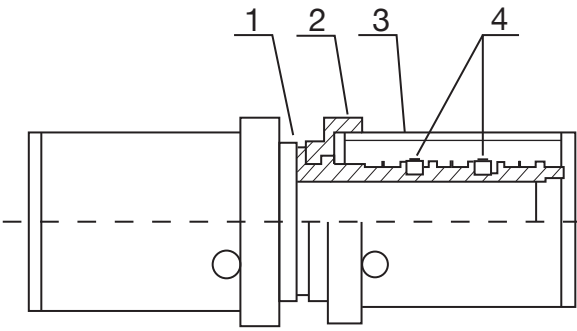
Structure Drawing And Main Components	Material
	<p>1. Main body: DZR Brass</p> <p>2. Isolating ring: Polyethylene</p> <p>3. Sleeve: Stainless Steel Sleeve SS304</p> <p>4. O-ring NBR</p>

(2) Pressure loss

F5 U-Profile Press Fittings For Gas Supply														
Nominal size	16		20		25		32		40		50		63	
Zeta values § (-)/ equivalent Pipe length eL [m]	§	eL	§	eL	§	eL	§	eL	§	eL	§	eL	§	eL
Press Elbow 90	1.08	0.90	1.00	1.08	1.06	1.41	0.94	2.00	0.93	2.31	1.08	0.90	1.08	0.90
Equal Straight Union	0.62	0.52	0.54	0.58	0.56	0.73	0.48	1.02	0.46	1.16	0.62	0.52	-	-
Straight at flow speed	0.67	1.58	0.59	1.50	0.65	1.56	0.53	1.44	0.51	1.42	0.67	1.58	0.67	1.58
Branch at flow speed	0.56	1.32	0.63	1.62	0.87	2.08	1.12	3.06	1.28	3.56	0.56	1.32	0.56	1.32
Equal Tee "Y" type	1.20	1.00	-	-	-	-	-	-	-	-	1.20	1.00	1.20	1.00

Zeta Value and equivalent pipe length of F5 u-profile press fittings for gas supply.
 A water velocity of 2m/s has been used for the calculation of equivalent pipe lengths

WaterPex F5 Fittings

Technical Information

(3) The torque resistance of thread

Thread Size	1/2"	3/4"	1"	1 1/4"	1 1/2"	2"	2 1/2"
Torque /N·m	75	100	125	160	200	250	300

(4) Fitting stress corrosion resistance

All fittings are tested according to ASTM B858 "Standard Test Method for Ammonia Vapour Test for Determining Susceptibility to Stress Corrosion Cracking in Copper Alloys"

It is required that there shall be no evidence of cracking when viewed with a microscope with a minimum magnification of 10X.